

# Deploy the IDS 8280 sensor

Published: 2024-04-02

Intrusion Detection System (IDS) sensors integrate with packet sensors to generate detections based on industry-standard IDS signatures. This guide explains how to install the rack-mounted IDS 8280 sensor.

## Installation prerequisites

To install the sensor, your environment must meet the following requirements:

### Sensor

1U of rack space and electrical connections for 2 x 750 W power supplies.

### Management

One 10/100/1000 BASE-T network port for sensor management.

### Monitoring (capture)

High performance interfaces: One to two network ports for connection to 25 GbE or 10 GbE sources of packet data.

Management + monitoring interfaces: One to three network ports for connection to 1 GbE sources of packet data.

### Network Access

Ensure that administrators can access the Administration settings on the sensor over TCP port 443.

For more information about the interfaces on the ExtraHop system, see the [ExtraHop Hardware FAQ](#).

## Rear panel ports

### EDA 8280

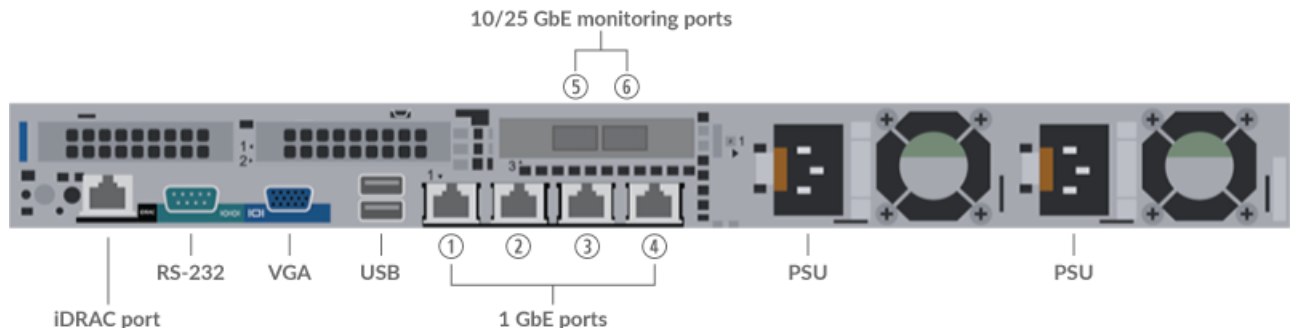

- One iDRAC interface port
- One RS-232 serial port to connect a console device
- One VGA port to connect an external display
- Two USB 3.0 ports to connect input devices such as a keyboard and mouse
- Two power ports to connect the sensor to an AC power source
- Four 10/100/1000 BASE-T network ports. Port 1 is the primary management port. Ports 2 - 4 are the management + monitor ports.
- Two 25 GbE-capable ports on one network adapter. Ports 5 and 6 are the high performance monitoring (capture) interfaces.

## Supported packet source connectivity

The IDS 8280 can accept packets through monitoring ports 2 through 6. The ports can be connected according to the table below.

IDS 8280 Connector	Peer Connector for Packet Source	Customer-Supplied Cabling	Supported Operating Speeds
<b>Transceiver-based Connectivity</b>			
25 GbE SFP28 SR transceiver	25 GbE SFP28 SR transceiver	Multi-mode fiber LC connectors	25 Gbps, 10 Gbps
	10 GbE SFP+ SR transceiver	Multi-mode fiber LC connectors	10 Gbps
<b>Direct Attach Connectivity</b>			
Customer-supplied SFP28 DAC cable, such as the Mellanox MCP2M00-Axxx series			25 Gbps
Customer-supplied RJ45 Ethernet cable			1 Gbps

### Traffic distribution guidelines

- Packets from the same flow should be received on the same interface, or on interfaces of the same network interface card (NIC).
- If your data feed does not require both interfaces on the NIC, disable the unconfigured interfaces in the Administration settings.
- A single high-performance ERSPAN target is expected to process 20 to 30 Gbps. On larger sensors, distribute ERSPAN traffic to more interfaces to scale traffic ingest.

## Set up the sensor

1. Rack mount the sensor.

Install the sensor in your data center with the included rack-mounting kit. The mounting kit supports most four-post racks with either round or square holes.

Orient the hardware to ensure proper airflow. The cold air intake is through the front of the sensor.

2. Connect port 1 to your management network.

This sensor has two 10/100/1000 BASE-T network ports. With a network patch cable, connect the management port on the sensor to your management network. Port 1 is the default management port.

3. Connect the monitoring port.

 **Important:** To ensure the best performance for initial device synchronization, connect all sensors to the console and then configure network traffic forwarding to the sensors.

With the appropriate network cable, connect a monitoring port on the sensor to a network tap or mirror port on the switch.

 **Important:** The IDS 8280 requires a duplicate feed of the traffic that is sent to the packet sensor.

 **Note:** The link lights on the monitoring interface ports do not illuminate until you register the ExtraHop sensor, recordstore, or packetstore with your product key.

- Optional: Connect the iDRAC port.

To enable remote management of the sensor, connect your management network to the iDRAC port with a network patch cable.

- Install the front bezel.

You must install the front bezel if you want to configure the sensor through the LCD display.

Insert the USB connector on the right side of the bezel into the USB port on the front of the sensor. Press and hold the release button on the left end of the bezel and push the bezel flush with the sensor until it snaps into place.

- Connect the power cords.

Connect the two supplied power cords to the power supplies on the back of the sensor, and then plug the cords into a power outlet. If the sensor does not power on automatically, press the power button

 on the front-right of the sensor.

## Configure the management IP address

DHCP is enabled by default on the ExtraHop system. When you power on the system, interface 1 attempts to acquire an IP address through DHCP. If successful, the IP address appears on the home screen of the LCD.

If your network does not support DHCP, you can configure a static IP address through the LCD menu on the front panel or through the command-line interface (CLI).

 **Important:** We strongly recommend [configuring a unique hostname](#). If the system IP address changes, the ExtraHop console can re-establish connection easily to the system by hostname.

## Configure a static IP address through the LCD

Complete the following steps to manually configure an IP address through the front bezel LCD controls.

- Make sure that the default management interface is connected to the network and the link status is active.
- Press the select button (✓) to begin.
- Press the down arrow button to select `Network`, and then press the select button.
- Press the down arrow to select `Set static IP`, and then press the select button.
- Press the left or right arrows to select the first digit to change, and then press the up or down arrows to change the digit to the desired number. Repeat this step for each digit you need to change. After you configure the desired IP address, press the select button.
- On the `Network mask` screen, press the left or right arrows to select the first digit to change, and then press the up or down arrows to change the digit to the desired number. Repeat this step for each digit you need to change. After you configure the desired network mask, press the select button.
- On the `Default gateway` screen, press the left or right arrows to select the first digit to change, and then press the up or down arrows to change the digit to the desired number. Repeat this step for each digit you need to change. After you configure the desired default gateway, press the select button.
- Confirm your modified network settings on the `Settings saved` screen, and then press any button to return to the `Network Menu`.
- Press the down arrow and scroll to `Set DNS servers`, and then press the select button.
- Press the left or right arrows on the `DNS1` screen to select the first digit to change, and then press the up or down arrows to change the digit to the desired number. Repeat this step for each digit you need to change, and then press the select button to continue to the `DNS2` screen.
- Configure a second DNS server.

12. Confirm the DNS settings on the `Settings saved` screen, and then press any button to return to the `Network Menu`.
13. Press the down arrow twice until `← Back` appears, and then press the select button.
14. Press the down arrow twice to select iDRAC. Configure the iDRAC DHCP, IP, mask, gateway, and DNS in the same manner as the IP address.
15. Press the `x` button to return to the main menu.

## Configure an IP address through the CLI

You can access the CLI by connecting a USB keyboard and SVGA monitor to the appliance or through an RS-232 serial (null modem) cable and a terminal emulator program. Set the terminal emulator to 115200 baud with 8 data bits, no parity, 1 stop bit (8N1), and hardware flow control disabled.

1. Establish a connection to the ExtraHop system.
2. At the login prompt, type `shell` and then press ENTER.
3. At the password prompt, type the system serial number and then press ENTER. The serial number is printed on a label on the back of the appliance. The serial number can also be found on the LCD display on the front of the appliance in the `Info` section.
4. Enable privileged commands:

```
enable
```

5. At the password prompt, type the serial number, and then press ENTER.
6. Enter configuration mode:

```
configure
```

7. Enter interface configuration mode:

```
interface
```

8. Run the `ip` command and specify the IP address and DNS settings in the following format:

```
ip ipaddr <ip_address> <netmask> <gateway> <dns_server>
```

For example:

```
ip ipaddr 10.10.2.14 255.255.0.0 10.10.1.253 10.10.1.254
```

9. Leave interface configuration mode:

```
exit
```

10. Save the running configuration file:

```
running_config save
```

11. Type `y` and then press ENTER.

## Configure the system

Perform the following procedures to configure the IDS sensor.

1. [Register your ExtraHop system](#).
2. [Connect to ExtraHop Cloud Services](#).
3. Connect your console to the sensor.
  - To connect to a self-managed console, see [Connect an ExtraHop console to an ExtraHop sensor](#).
  - To connect to Reveal(x) 360, see [Connect to Reveal\(x\) 360 from self-managed sensors](#).

4. Join the IDS sensor to a site.
  - For Reveal(x) Enterprise
    1. On the Manage Connected Appliances page of the console, click **Actions** next to the IDS sensor and then click **Join Site** from the Appliance Actions drop-down list.
    2. From the Associated Site drop-down list, click the name of the site you want to join. You must join a site that has the same network feed as the IDS sensor.
    3. Click **Join Site**.
  - For Reveal(x) 360
    1. On the Reveal(x) 360 **Administration** > **Sensors** page, select the checkbox next to the name of the IDS sensor.
    2. On the Sensor Details pane, select the name of the site you want to join from the **Associated Site** drop-down list. You must join a site that has the same network feed as the IDS sensor.
    3. Click **Join Site**.
5. Optional: Select the IDS Detections [tuning parameter](#)  to enable detections for inbound traffic from external endpoints.

By default, the ExtraHop system will only generate detections for internal traffic.
6. Complete the recommended procedures in the [post-deployment checklist](#) .