

Port Channeling

Published: 2023-04-22

Depending on your network configuration, you might need to configure port channeling to provide a data feed to your sensor. This guide illustrates several example configurations with the EDA 9200.

Here are some important things to know about port channeling:

- Port channels can be configured on all rack-mounted ExtraHop sensors.
- Port channels can combine 10/25 GbE ports or 1 GbE ports; however, 1 GbE and 10/25 GbE ports cannot be combined.
- Port channels must be configured on interfaces that are set as monitoring ports.
- Port channels must have a static configuration. LACP is not supported.
- Port channels can spread a single flow across multiple physical interfaces which can negatively affect performance, store data as uni-directional traffic, and result in incomplete protocol analysis. Complete one of the following steps to avoid these issues:
 - Turn on symmetric hashing on the switch. A single flow (both received and transmitted) is sent to a single port on the Discover appliance.
 - Enable software RSS on the sensor to ensure that all flow packets are reassembled before analysis begins.

The following diagram shows the back panel of the EDA 9200. Slots 1 and 4 represent the NICs receiving data.

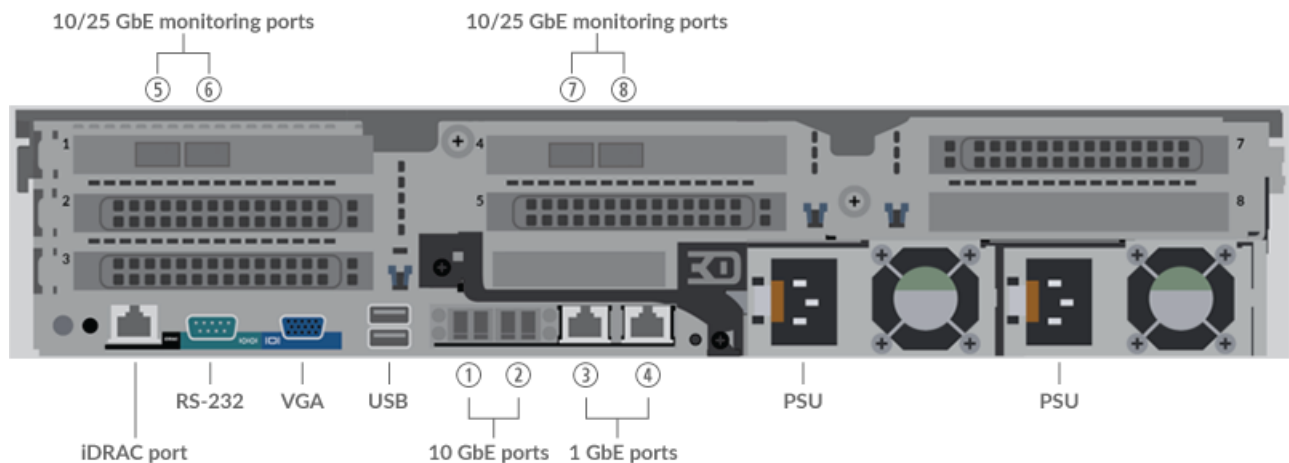

Four data sources (port channeling not required)

As a comparison, the following diagram shows four sources of traffic going to the four 10/25 GbE ports on the appliance.

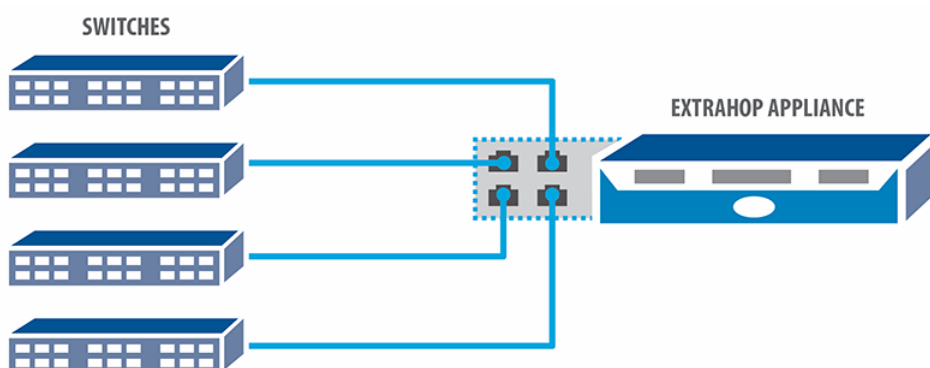

Two data sources with two channels (port channeling required)

The following diagram shows two sources of traffic fed through two port channels going to the four 10/25 GbE ports on the appliance.

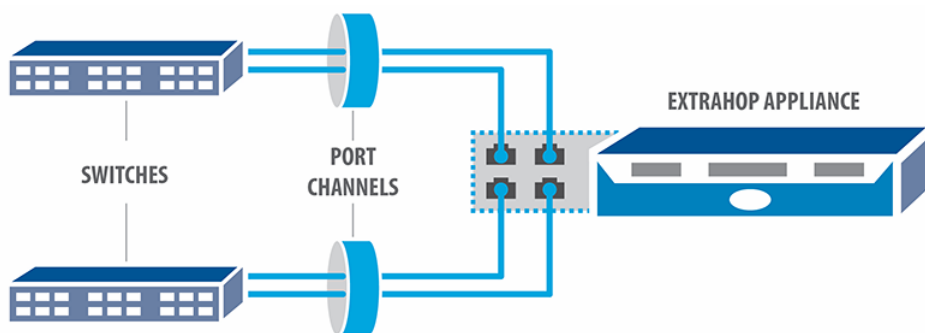

One data source with one channel (port channeling required)

The following diagram shows one source of traffic fed through one port channel going to the four 10/25 GbE ports on the appliance.

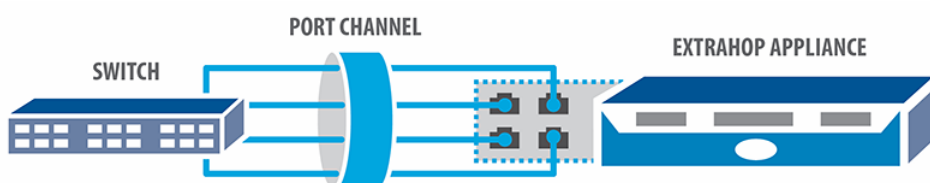

One data source with two channels (port channeling required)

The following diagram shows one source of traffic fed through two port channels going to the four 10/25 GbE ports on the appliance. The first port channel is sent to the two ports on the NIC in slot 1 and the second port channel is sent to the remaining two ports on the NIC in slot 4. This configuration does not require symmetric hashing.

