

Connect sensors and console to the packetstore

Published: 2022-06-30

Before you can query for packets, you must connect the console and all sensors to the packetstore.

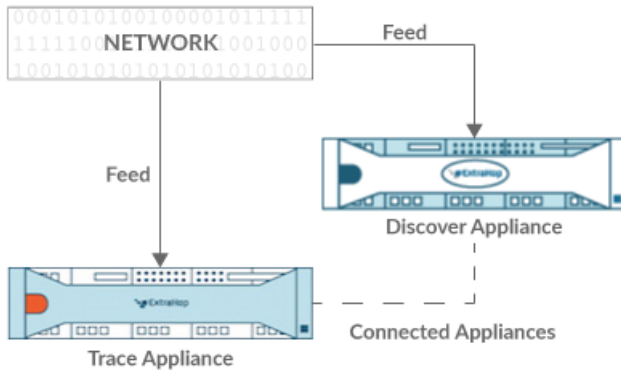

Figure 1: Connected to a sensor

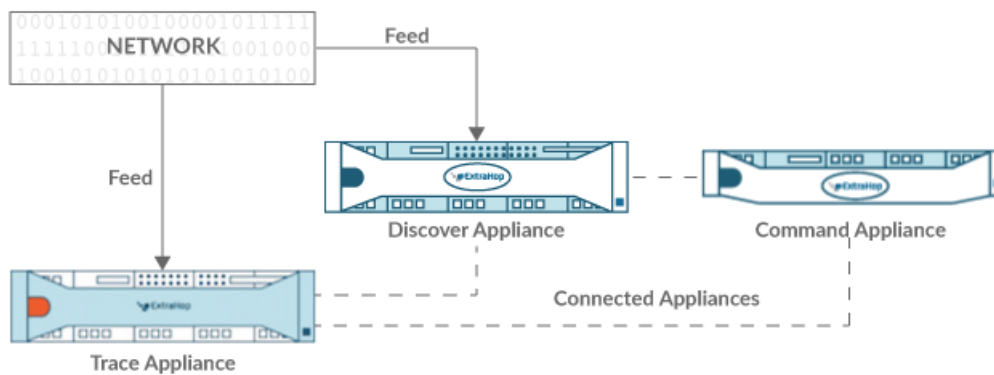

Figure 2: Connected to sensor and console

1. Log in to the Administration settings on the sensor.
2. In the ExtraHop Trace Settings section, click **Connect Trace Appliances**.
3. Type the hostname or IP address of the packetstore in the Appliance hostname field.
4. Click **Pair**.
5. Note the information listed in the Fingerprint field. Verify that the fingerprint listed on this page matches the fingerprint of the packetstore listed on the Fingerprint page in the Administration settings of the packetstore.
6. Type the password of the packetstore `setup` user in the Trace Setup Password field.
7. Click **Connect**.
8. To connect additional packetstores, repeat steps 2 through 7.

 **Note:** You can connect a sensor to twenty or fewer packetstores, and you can connect a console to fifty or fewer packetstores.

9. If you have a console, log in to the Administration settings on the console and repeat steps 3 through 7 for all packetstores.