

# Port Channeling

Published: 2021-12-01

Depending on your network configuration, you might need to configure port channeling to provide a data feed to your ExtraHop appliance. This guide illustrates several example configurations with the EDA 9200.

Here are some important things to know about port channeling:

- Port channels can be configured on all rack-mounted ExtraHop Discover appliances.
- Port channels can combine 10/25 GbE ports or 1 GbE ports; however, 1 GbE and 10/25 GbE ports cannot be combined.
- Port channels must be configured on interfaces that are set as monitoring ports.
- Port channels must have a static configuration. LACP is not supported.
- Port channels can spread a single flow across multiple physical interfaces which can negatively affect performance, store data as uni-directional traffic, and result in incomplete protocol analysis. Complete one of the following steps to avoid these issues:
  - Turn on symmetric hashing on the switch. A single flow (both received and transmitted) is sent to a single port on the Discover appliance.
  - Enable software RSS on the Discover appliance to ensure that all flow packets are reassembled before analysis begins.

The following diagram shows the back panel of the EDA 9200. Slots 1 and 4 represent the NICs receiving data.

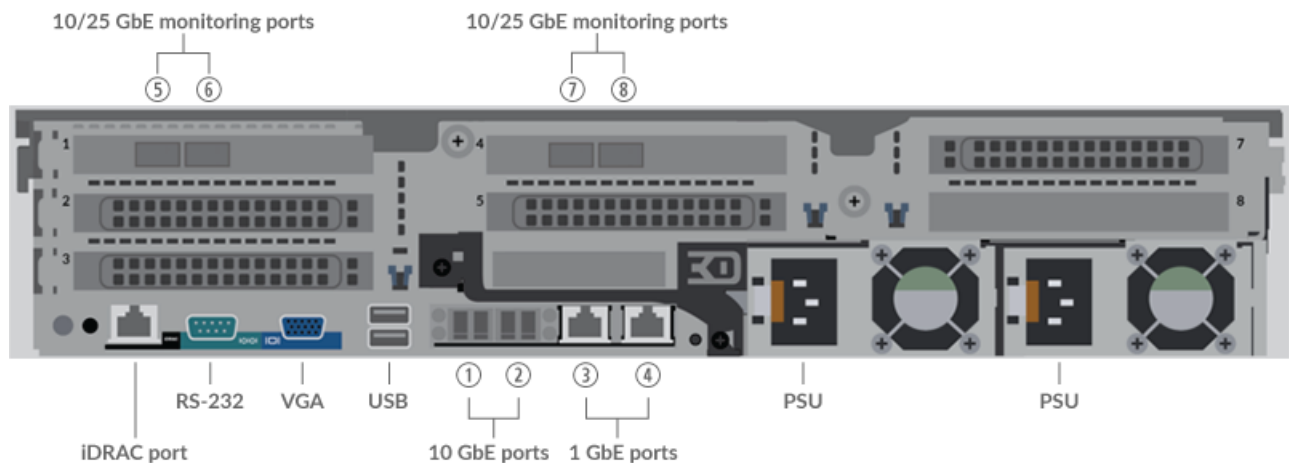

## Four data sources (port channeling not required)

As a comparison, the following diagram shows four sources of traffic going to the four 10/25 GbE ports on the Discover appliance.

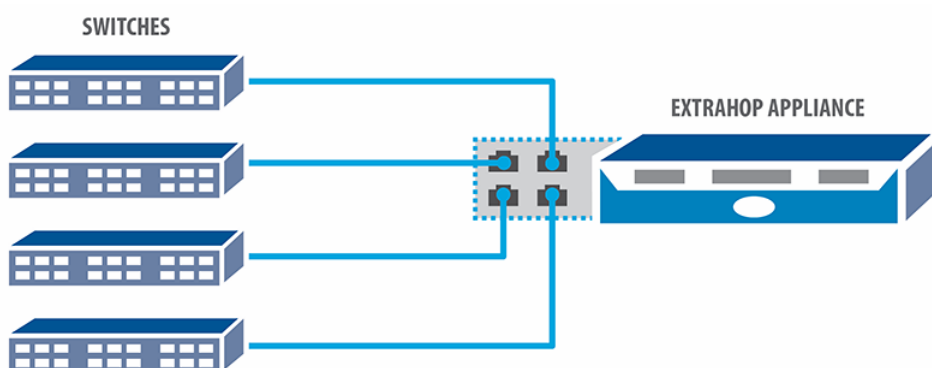

## Two data sources with two channels (port channeling required)

The following diagram shows two sources of traffic fed through two port channels going to the four 10/25 GbE ports on the Discover appliance.

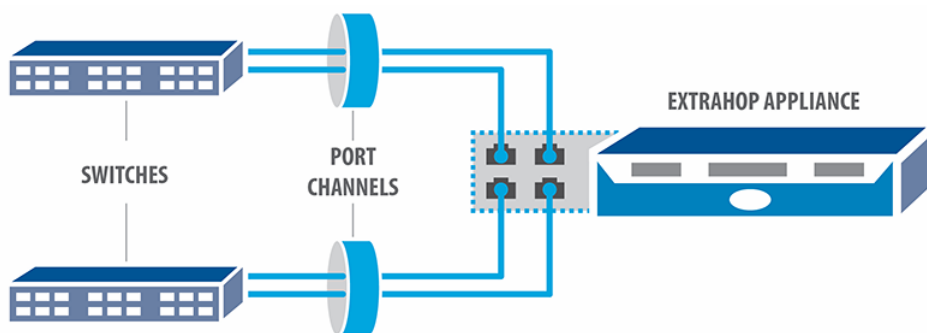

## One data source with one channel (port channeling required)

The following diagram shows one source of traffic fed through one port channel going to the four 10/25 GbE ports on the Discover appliance.

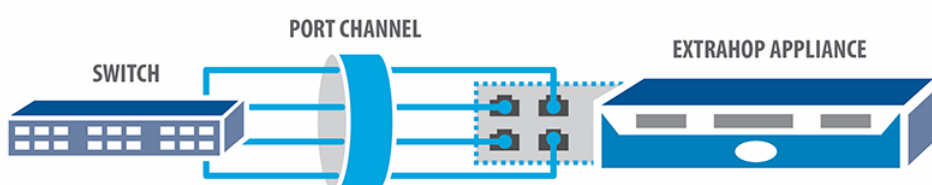

## One data source with two channels (port channeling required)

The following diagram shows one source of traffic fed through two port channels going to the four 10/25 GbE ports on the Discover appliance. The first port channel is sent to the two ports on the NIC in slot 1 and the second port channel is sent to the remaining two ports on the NIC in slot 4. This configuration does not require symmetric hashing.

