

Connect the Discover and Command appliances to the Trace appliance

Published: 2021-09-08

After you deploy the Trace appliance, you must establish a connection from all ExtraHop Discover and Command appliances to the Trace appliance before you can query for packets.

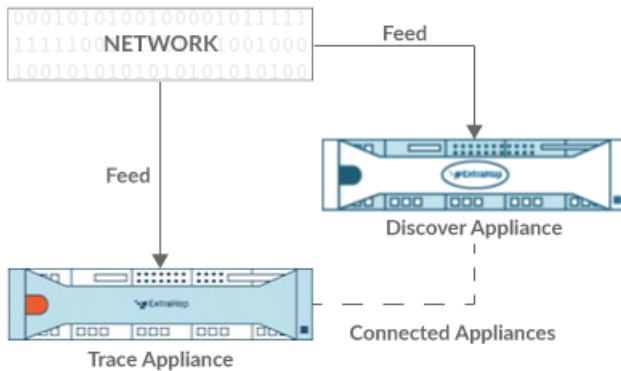

Figure 1: Connected to Discover Appliance

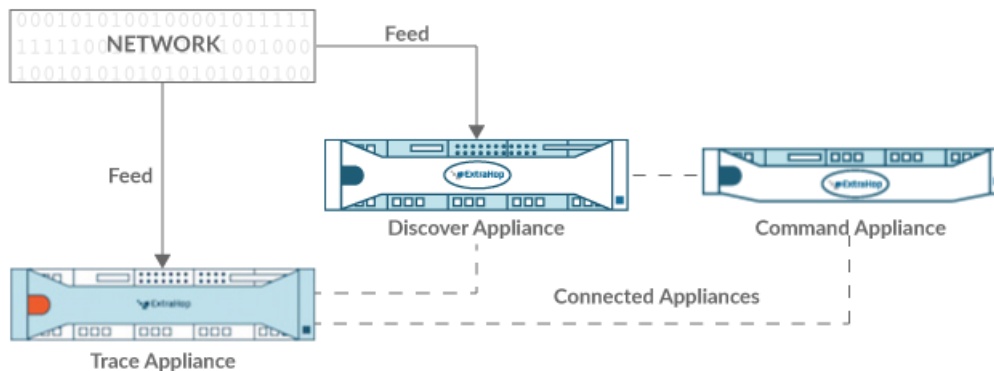

Figure 2: Connected to Discover and Command Appliance

1. Log in to the Administration settings on the Discover appliance.
2. In the ExtraHop Trace Settings section, click **Connect Trace Appliances**.
3. Type the hostname or IP address of the Trace appliance in the Appliance hostname field.
4. Click **Pair**.
5. Note the information listed in the Fingerprint field. Verify that the fingerprint listed on this page matches the fingerprint of the Trace appliance listed on the Fingerprint page in the Administration settings of the Trace appliance.
6. Type the password of the Trace appliance `setup` user in the Trace Setup Password field.
7. Click **Connect**.
8. To connect additional Trace appliances, repeat steps 2 through 7.

Note: You can connect a Discover appliance to four or fewer Trace appliances. However, you can connect a Command appliance to an unlimited number of Trace appliances.

9. If you have a Command appliance, log in to the Administration settings on the Command appliance and repeat steps 3 through 7 for all Trace appliances.