

# Deploy the ExtraHop Trace Appliance with VMware

Published: 2021-03-17

This guide explains how to deploy the virtual ExtraHop Trace appliances (ETA 1150v and ETA 6150v) on the VMware ESXi/ESX platform.

## Virtual machine requirements

Your environment must meet the following requirements to deploy a virtual Trace appliance:

- An existing installation of VMware ESX or ESXi server version 6.0 or later capable of hosting the virtual Trace appliance. The virtual Trace appliances have the following resource requirements:

ETA 1150v	ETA 6150v
2 vCPUs	18 vCPUs
16 GB RAM	64 GB RAM
4 GB system disk	4 GB system disk 250 GB for a second system disk
1 TB for a packetstore disk	Packetstore disk
You can reconfigure the disk size between 50 GB and 4 TB before deploying, if desired.	You must manually add a third virtual disk between 1 TB and 25 TB at the time of deployment to store packet data. You can add up to 16 virtual disks to increase storage capacity and performance of the Trace appliance. The total capacity of all disks cannot exceed 25 TB.

The hypervisor CPU should provide Supplemental Streaming SIMD Extensions 3 (SSSE3) support.

Follow these guidelines to ensure the virtual appliance functions properly:

- If you want to deploy more than one virtual Trace appliance, create the new instance with the original deployment package or clone an existing instance that has never been started.
- Always choose thick provisioning. The ExtraHop packetstore requires low-level access to the complete drive and is not able to grow dynamically with thin provisioning.
- Do not change the default disk size after the appliance is deployed. Size the virtual disk either smaller or larger than the default 1TB before deploying. We do not support changing the original disk size or adding additional disks after the virtual machine is deployed.
- Do not migrate the virtual machine from one host or storage location to another. Although it is possible to migrate when the datastore is on a remote SAN, ExtraHop does not recommend this configuration. If you must migrate the VM to a different host after deployment, shut down the virtual appliance first and then migrate with a tool such as VMware VMotion. Live migration is not supported.
- For maximum performance and compatibility, deploy Discover and Trace appliances in the same datacenter.

## Performance considerations

-  **Important:** The ETA 6150v is capable of capturing packets to disk at a throughput of 10 Gbps, but only with properly provisioned network and disk bandwidth. To achieve peak performance when capturing traffic from physical network interfaces, you must ensure

that there is a 10 GbE physical NIC (or equivalent available bandwidth across multiple 10 GbE physical NICs) dedicated to the ETA 6150v appliance. Similarly, you must ensure that 10 Gbps of disk bandwidth is allocated to the ETA 6150v appliance. With HDDs, this disk bandwidth typically requires dedicating 12 or more disks to the virtual appliance. Storage configurations with a small number of disks or with a large number of disks that are shared among multiple virtual appliances are unlikely to sustain packet capture at 10 Gbps.

## Network requirements

Appliance	Intra-VM	External
ETA 1150v	<p>One 1 Gbps Ethernet network port is required for management. A dedicated port is not necessary. You can take advantage of the same physical NIC as other VMs in your environment.</p> <p>The management port must be accessible on port 443.</p>	<p>One 1 Gbps Ethernet network port for the physical port mirror. We recommend that you duplicate the feed of the traffic that is sent to the Discover appliance to take advantage of the ExtraHop workflow.</p>
ETA 6150v	<p>A 1 Gbps Ethernet network port is required for management. A dedicated port is not necessary. You can take advantage of the same physical NIC as other VMs in your environment.</p> <p>The management port must be accessible on port 443.</p>	<p>A 10 Gbps Ethernet network port for the physical port mirror. To achieve 10 Gbps throughput, you must have 10 GbE or faster NIC ports in your ESXi server.</p> <p>We recommend that you duplicate the feed of the traffic that is sent to the Discover appliance to take advantage of the ExtraHop workflow.</p>

## Interface modes

Each interface can be configured as follows:

Interface	Interface mode
Interface 1	<ul style="list-style-type: none"> <li>• Disabled</li> <li>• Management Port</li> <li>• Management Port + RPCAP/ERSPAN/VXLAN Target</li> </ul>
Interface 2	<ul style="list-style-type: none"> <li>• Disabled</li> <li>• Monitoring Port (receive only)</li> <li>• Management Port</li> <li>• Management Port + RPCAP/ERSPAN/VXLAN Target</li> <li>• High-performance ERSPAN Target (ETA 6150v)</li> </ul>
Interface 3 (ETA 6150v)	<ul style="list-style-type: none"> <li>• Disabled</li> <li>• Monitoring Port (receive only)</li> <li>• Management Port</li> </ul>

Interface	Interface mode
	<ul style="list-style-type: none"> <li>• Management Port + RPCAP/ERSPAN/VXLAN Target</li> <li>• High-performance ERSPAN Target</li> </ul>
Interface 4 (ETA 6150v)	<ul style="list-style-type: none"> <li>• Disabled</li> <li>• Monitoring Port (receive only)</li> <li>• Management Port</li> <li>• Management Port + RPCAP/ERSPAN/VXLAN Target</li> <li>• High-performance ERSPAN Target</li> </ul>

Virtual Extensible LAN (VXLAN) packets are received on UDP port 4789.

The ExtraHop system supports the following ERSPAN implementations:

- ERSPAN Type I
- ERSPAN Type II
- ERSPAN Type III
- Transparent Ethernet Bridging, which is an ERSPAN-like encapsulation commonly found in virtual switch implementations such as the VMware VDS and Open vSwitch.

## Deploy the OVA file through the VMware vSphere web client

ExtraHop distributes the virtual Trace appliance package in the open virtual appliance (OVA) format.

### Before you begin

If you have not already done so, download the ExtraHop Trace virtual appliance OVA file for VMware from the [ExtraHop Customer Portal](#).

1. Start the VMware vSphere web client and connect to your ESX server.
2. Select the datacenter where you want to deploy the virtual Trace appliance.
3. Select **Deploy OVF Template...** from the Actions menu.
4. Follow the wizard prompts to deploy the virtual machine. For most deployments, the default settings are sufficient.
  - a) Select **Local file** and then click **Browse...**
  - b) Select the OVA file on your local machine and then click **Open**.
  - c) Click **Next**.
  - d) Review the virtual appliance details and then click **Next**.
  - e) Specify a name and location for the appliance and then click **Next**.
  - f) Select a resource location and then click **Next**.
  - g) For disk format, select **Thick Provision Lazy Zeroed** and then click **Next**.
  - h) Map the OVF-configured network interface labels with the correct ESX-configured interface labels and then click **Next**.
5. Verify the configuration and then complete the following steps:
  - For the ETA 1150v
 

If you do not want to resize the packetstore disk, select the Power on after deployment checkbox and then click **Finish** to begin the deployment.

If you want to resize the packetstore disk:

    1. Click **Finish** to begin the deployment. When the deployment is complete, select **Edit Settings** from the Actions menu.

2. Type a new size in the Hard disk 2 field. The minimum disk size is 50 GB and the maximum is 4 TB.
3. From the Actions menu, select **Power > Power on**.
- For the ETA 6150v
  1. From the **Actions** drop-down list, select **Edit Settings...** to configure the packetstore disk.
  2. From the **New device** drop-down list, select **New Hard Disk**, and then click **Add**.
  3. Type a size in the Hard disk 3 field. The minimum disk size is 1 TB and the maximum disk size is 25 TB.
  4. Specify a datastore for the packetstore disk. To help ensure that the Trace appliance can write packets at peak throughput without contention from other workloads, ExtraHop recommends that disk 3 be placed on a separate datastore than disks 1 and 2. The datastore must be backed by a high performance disk volume dedicated to the packetstore workload, and not shared with other virtual machines.
  5. In the Mode section, select **Independent** and then select **Persistent**.
  6. Repeat steps b through e to add additional packetstore disks.
  7. Click **Finish** to begin the deployment.
  8. Find the ETA 6150v virtual machine in the vSphere Web Client inventory.
  9. Right-click the virtual machine and click **Edit Settings**.
  10. Click **VM Options** and then click **Advanced**.
  11. Select **Medium** from the Latency Sensitivity drop-down menu.
  12. Click **OK**.
  13. From the Actions menu, select **Power > Power on**.
6. Select the virtual Trace appliance in the ESX Inventory and then select **Open Console** from the Actions menu.
7. Click the console window and then press ENTER to display the IP address. DHCP is enabled by default on the virtual Trace appliance. To configure a static IP address, see the [Configure a static IP address through the CLI](#) section.
8. Begin sending packets to your monitoring port or ports. Either connect a physical Ethernet port to the Monitoring Port through a virtual switch, or configure ERSPAN, RPCAP, or VXLAN sources to send traffic to the appropriate appliance IP address.

## Configure a static IP address through the CLI

The ExtraHop system is delivered with DHCP enabled. If your network does not support DHCP, no IP address is acquired, and you must configure a static address manually.

 **Important:** For deployments that include a Discover appliance that is connected to a Command appliance, we strongly recommend [configuring a unique hostname](#). If the IP address on the sensor is changed, the Command appliance can re-establish connection easily to the sensor by hostname.

1. Access the CLI through an SSH connection, by connecting a USB keyboard and SVGA monitor to the appliance, or through an RS-232 serial cable and a terminal emulator program. The terminal emulator must be set to 115200 bps with 8 data bits, no parity, 1 stop bit (8N1), and hardware flow control should be disabled.
2. At the login prompt, type `shell` and then press ENTER.
3. At the password prompt, type `default`, and then press ENTER.
4. To configure the static IP address, run the following commands:
  - a) Enable privileged commands:

```
enable
```

- b) At the password prompt, type `default`, and then press ENTER.

c) Enter configuration mode:

```
configure
```

d) Enter the interface configuration mode:

```
interface
```

e) Run the `ip` command and specify the IP address and DNS settings in the following format: `ip ipaddr <ip_address> <netmask> <gateway> <dns_server>`

For example:

```
ip ipaddr 10.10.2.14 255.255.0.0 10.10.1.253 10.10.1.254
```

f) Leave the interface configuration section:

```
exit
```

g) Save the running config file:

```
running_config save
```

h) Type `y` and then press ENTER.

## Configure the Trace appliance

Open a web browser and log in to the Administration settings on the Trace appliance through the configured IP address and complete the following procedures. The default login name is `setup` and the password is `default`.

- [Register your ExtraHop system](#)
- [Connect the Discover and Command appliances to the Trace appliance](#)
- Review the [ExtraHop Post-deployment Checklist](#) and configure additional Trace appliance settings.

## Connect the Discover and Command appliances to the Trace appliance

After you deploy the Trace appliance, you must establish a connection from all ExtraHop Discover and Command appliances to the Trace appliance before you can query for packets.

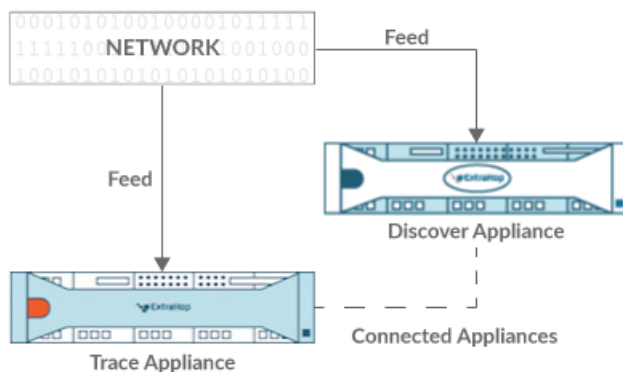

Figure 1: Connected to Discover Appliance

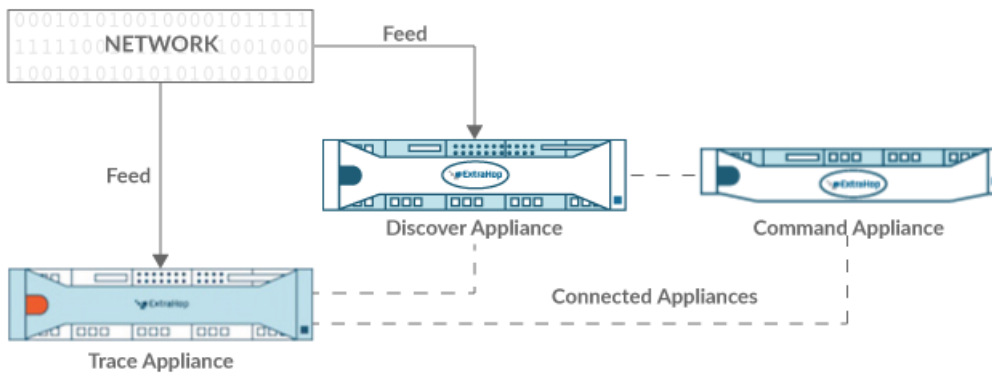

Figure 2: Connected to Discover and Command Appliance

1. Log in to the Administration settings on the Discover appliance.
2. In the ExtraHop Trace Settings section, click **Connect Trace Appliances**.
3. Type the hostname or IP address of the Trace appliance in the Appliance hostname field.
4. Click **Pair**.
5. Note the information listed in the Fingerprint field. Verify that the fingerprint listed on this page matches the fingerprint of the Trace appliance listed on the Fingerprint page in the Administration settings of the Trace appliance.
6. Type the password of the Trace appliance `setup` user in the Trace Setup Password field.
7. Click **Connect**.
8. To connect additional Trace appliances, repeat steps 2 through 7.



**Note:** You can connect a Discover appliance to four or fewer Trace appliances. However, you can connect a Command appliance to an unlimited number of Trace appliances.

9. If you have a Command appliance, log in to the Administration settings on the Command appliance and repeat steps 3 through 7 for all Trace appliances.

## Verify the configuration

After you have deployed and configured the Trace appliance, verify that the Trace appliance can collect packets through the Discover and Command appliances.

### Before you begin

You must have a minimum user privilege of **view and download packets** to perform this procedure.

1. Log in to the ExtraHop system through `https://<extrahop-hostname-or-IP-address>`.
2. Make sure **Packets** appears in the top menu.



3. Click **Packets** to start a new packet query. You should now see a list of the collected packets.

If the Packets menu item does not appear, revisit the [Connect the Discover and Command appliances to the Trace appliance](#) section. If no results are returned when you perform a packet query, check your network settings. If either issue persists, contact [ExtraHop Support](#).