

Deploy the ExtraHop Trace 6150 Appliance

Published: 2020-02-24

This guide explains how to install the rack-mounted ETA 6150 ExtraHop Trace appliances.

System requirements

Appliance

- 2U of rack space
- 2x750W of power

Network Access

TCP ports 80 and 443 must be open.

These ports enable you to administer the Trace appliance through the ExtraHop Web UI. Requests sent to port 80 are automatically redirected to HTTPS port 443.

! Important: For maximum performance and compatibility, deploy Discover and Trace appliances in the same datacenter.

Rear panel ports

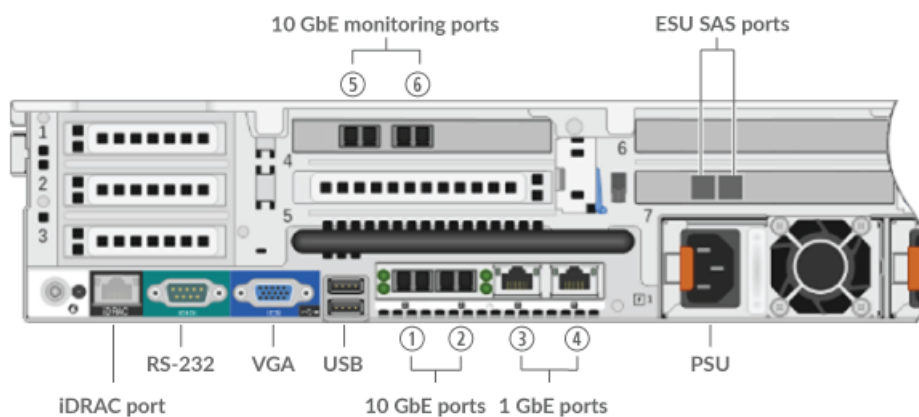

- One iDRAC interface port
- One RS-232 serial port to connect a console device
- One VGA port to connect an external display
- Two USB 3.0 ports to connect input devices such as a keyboard and mouse
- Two 10/100/1000 BASE-T network ports. Port 3 is the primary management port.
- Four 10 GbE ports. Ports 5 and 6 are the monitoring (capture) interfaces.
- Two power ports to connect the appliance to an AC power source

Set up the appliance

1. Rack mount the Trace appliance.
Install the Trace appliance in your data center with the included rack-mounting kit. The mounting kit supports most four-post racks with either round or square holes.
2. Connect port 3.
Connect your management network to the 1 GbE interface on port 3.

3. Connect the 10 GbE port.
Connect your network data feed to the 10 GbE interface on port 5, port 6, or both.
 -  **Important:** The Trace appliance requires a duplicate feed of the traffic that is sent to the Discover appliance.
4. Connect the power cords.
Connect the two supplied power cords to the power supplies on the back of the appliance.
5. Optional: Connect any extended storage units. For information about configuring extended storage units, see [Add storage capacity to the ExtraHop Trace appliance](#).
6. Plug the power cords into a power outlet. If the appliance does not power on automatically, press the power button on the front of the appliance.

Configure the management IP address

DHCP is enabled by default on the Trace appliance. When you power on the appliance, interface 3 attempts to acquire an IP address through DHCP. If successful, the IP address appears on the home screen of the LCD. If an IP address has not been configured, the LCD displays **No IP**.

If your network does not support DHCP, you can configure a static IP address through the LCD menu on the front panel or through the command-line interface (CLI).

Configure a static IP address through the front panel

Complete the following steps to manually configure an IP address through the front panel LCD controls.

1. Make sure that the default management interface is connected to the network and the link status is active.
2. Press the select button (#) to begin.
3. Press the right arrow (>) button to select **Net** and then press the select button.
4. Press the right arrow button twice to highlight **DHCP** and then press the select button.
5. Press the right arrow button to select **Static** and then press the select button.
6. Press the right arrow button to select **IP** and then press the select button. The currently configured IP address appears.
7. Press the right arrow button until the first digit you want to change is highlighted.
8. Press the select button. The digit blinks when selected. While the digit is blinking, press the left arrow (<) or right arrow (>) button to change the digit value.
9. After you have chosen the correct digit, press the select button.
10. Repeat steps 7-9 for each remaining digit you want to change.
11. Press the left arrow button to navigate to the up arrow ↑ on the display and press the select button.
12. On the Save screen, select **Yes** and then press the select button.
13. Wait a moment to be redirected to the Net screen. Repeat the actions above to set the mask, gateway, and up to two DNS servers.
14. Optional: Configure the iDRAC DHCP, IP, mask, gateway, and DNS in the same manner as the IP address.

Configure a static IP address through the CLI

You can access the CLI by connecting a USB keyboard and SVGA monitor to the appliance or through an RS-232 serial cable and a terminal-emulator program. The terminal emulator must be set to 115200 bps with 8 data bits, no parity, 1 stop bit (8N1), and hardware flow control should be disabled.

1. Establish a connection to the ExtraHop appliance.
2. At the login prompt, type **shell** and then press ENTER.

3. At the password prompt, type the service tag number found on the pullout tab on the front of the appliance, and then press ENTER.
4. To configure a static IP address, run the following commands:

- a) Enable privileged commands:

```
enable
```

- b) At the password prompt, type the service tag number, and then press ENTER.
- c) Enter configuration mode

```
configure
```

- d) Enter the interface configuration mode to configure interface 3:

```
interface 3
```

- e) Run the `ip` command and specify the IP address and DNS settings in the following format: `ip ipaddr <ip_address> <netmask> <gateway> <dns_server>`

For example:

```
ip ipaddr 10.10.2.14 255.255.0.0 10.10.1.253
10.10.1.254
```

- f) Leave the interface configuration section:

```
exit
```

- g) Save the running config file:

```
running_config save
```

- h) Type `y` and then press ENTER.

After you assign a static IP address, the IP address appears on the LCD at the front of the appliance.

Configure the Trace appliance

Open a web browser and log into the Admin UI on the Trace appliance through the configured IP address with the `setup` user account. The password is the system serial number that appears in the Info section of the LCD display and on the label on the back of the appliance.

- [Register your ExtraHop appliance](#) 
- [Connect the Discover and Command appliances to the Trace appliance](#)
- Review the [ExtraHop Post-deployment Checklist](#)  and configure additional Trace appliance settings.

Connect the Discover and Command appliances to the Trace appliance

After you deploy the Trace appliance, you must establish a connection from all ExtraHop Discover and Command appliances to the Trace appliance before you can query for packets.

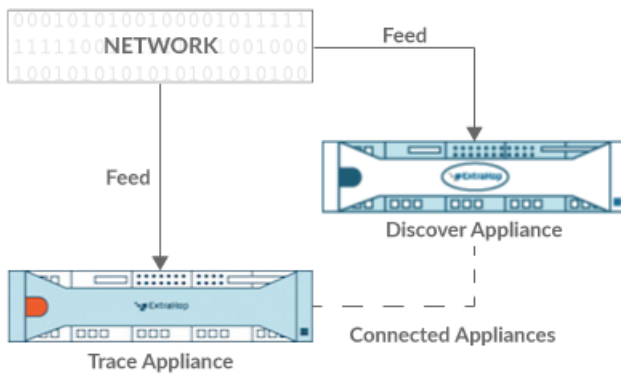

Figure 1: Connected to Discover Appliance

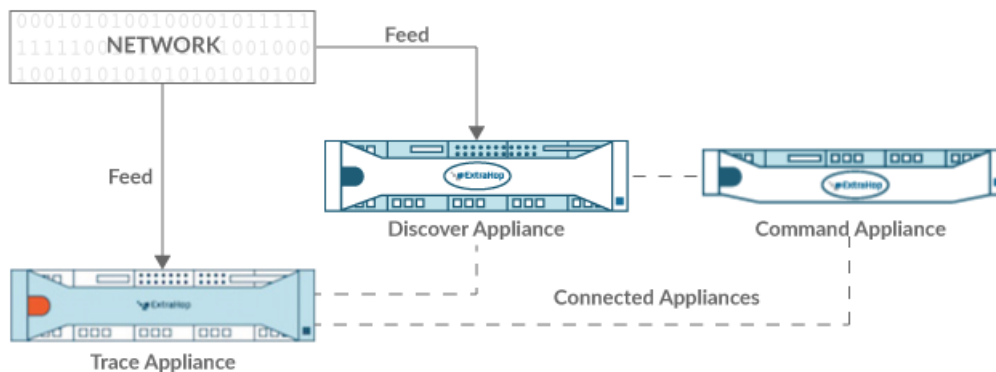



Figure 2: Connected to Discover and Command Appliance

1. Log into the Admin UI on the Discover appliance.
2. In the ExtraHop Trace Settings section, click **Connect Trace Appliances**.
3. Type the hostname or IP address of the Trace appliance in the Appliance hostname field.
4. Click **Pair**.
5. Note the information listed in the Fingerprint field. Verify that the fingerprint listed on this page matches the fingerprint of the Trace appliance listed on the Fingerprint page in the Admin UI of the Trace appliance.
6. Type the password of the Trace appliance `setup` user in the Trace Setup Password field.
7. Click **Connect**.
8. To connect additional Trace appliances, repeat steps 2 through 7.

 **Note:** You can connect a Discover appliance to four or fewer Trace appliances. However, you can connect a Command appliance to an unlimited number of Trace appliances.

9. If you have a Command appliance, log into the Admin UI on the Command appliance and repeat steps 3 through 7 for all Trace appliances.

Verify the configuration

After you have deployed and configured the Trace appliance, verify that the Trace appliance can collect packets through the Discover and Command appliances.

Before you begin

You must have a minimum user privilege of **view and download packets** to perform this procedure.

1. Log into the Web UI on the Discover or Command appliance.
2. Make sure **Packets** appears in the top menu.

3. Click **Packets** to start a new packet query. You should now see a list of the collected packets.

If the Packets menu item does not appear, revisit the [Connect the Discover and Command appliances to the Trace appliance](#) section. If no results are returned when you perform a packet query, check your network settings. If either issue persists, contact [ExtraHop Support](#).